

# DRILLTEQ V-310

The "Raumwunder".

The next step in vertical CNC machining.

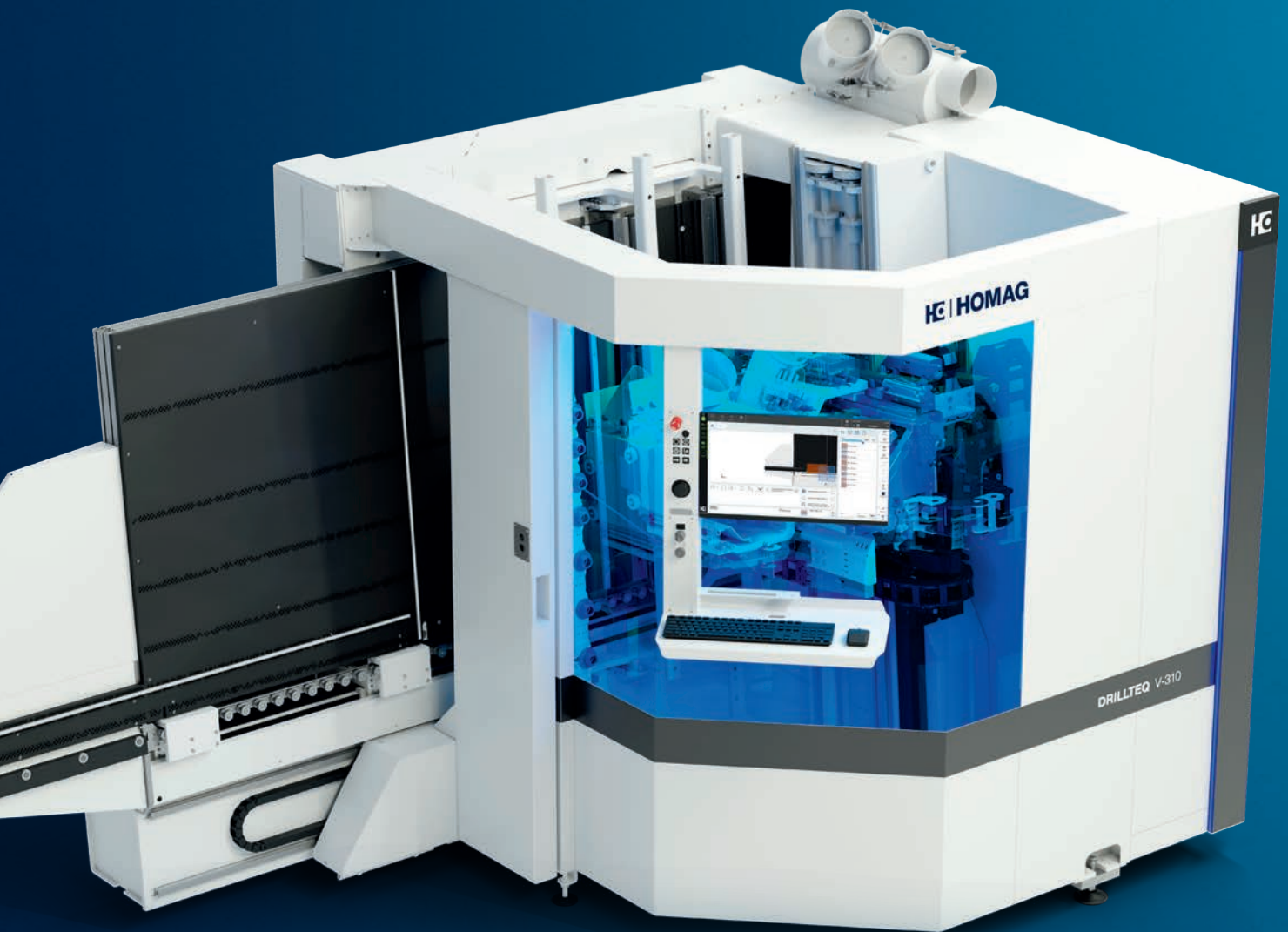





## DRILLTEQ V-310 – The "Raumwunder".

The smart concept of the DRILLTEQ V-310 offers the widest possible range of functions in the smallest possible space. This saves you a considerable amount of time in your everyday work. In its optimally utilized 11 m<sup>2</sup>, the DRILLTEQ V-310 offers more drilling, more milling and more grooving than ever before. Even door machining is now possible, as is any type of connector machining. So much CNC machining, in so little space, makes it our "Raumwunder".

HOMAG CNC processing centers already offer the technology of the future, and there's a good reason for that: Tradition.

"Made in Germany" is both an incentive for you, and an obligation for us. Customers all over the world associate the highest standards with this seal of quality. We fulfill them.

### CONTENT

- 04 DRILLTEQ V-310 - Highlights
- 06 Quality and innovation
- 08 Main spindle technology
- 09 Aggregates and tool changers
- 10 Drilling technology
- 12 Workpiece handling
- 14 intelliGuide operator assistance
- 16 Accuracy check
- 17 Measuring
- 18 Workpiece return system
- 20 Dowel technology
- 22 Furniture connectors
- 23 Door processing
- 24 Software
- 26 powerTouch2 operating concept
- 27 Safety concept
- 28 Robot Integration
- 32 LifeCycleServices LCS
- 34 Technical data

# DRILLTEQ V-310

## Highlights at a glance

### MINIMAL SPACE REQUIREMENT

With its 11 m<sup>2</sup>, the machine fits in seamlessly.

### EXTENSIVE EQUIPMENT

Up to 45 drilling spindles, 2 grooving saws, dowel unit and a C-axis with unit interface.

### ENERGY-EFFICIENT MACHINING

The collet system works without setup times and vacuum. This saves time, energy and costs.

### ERGONOMIC PROCESSING

The new design allows intuitive and ergonomic operation during tool change, loading, and during daily work with the machine.



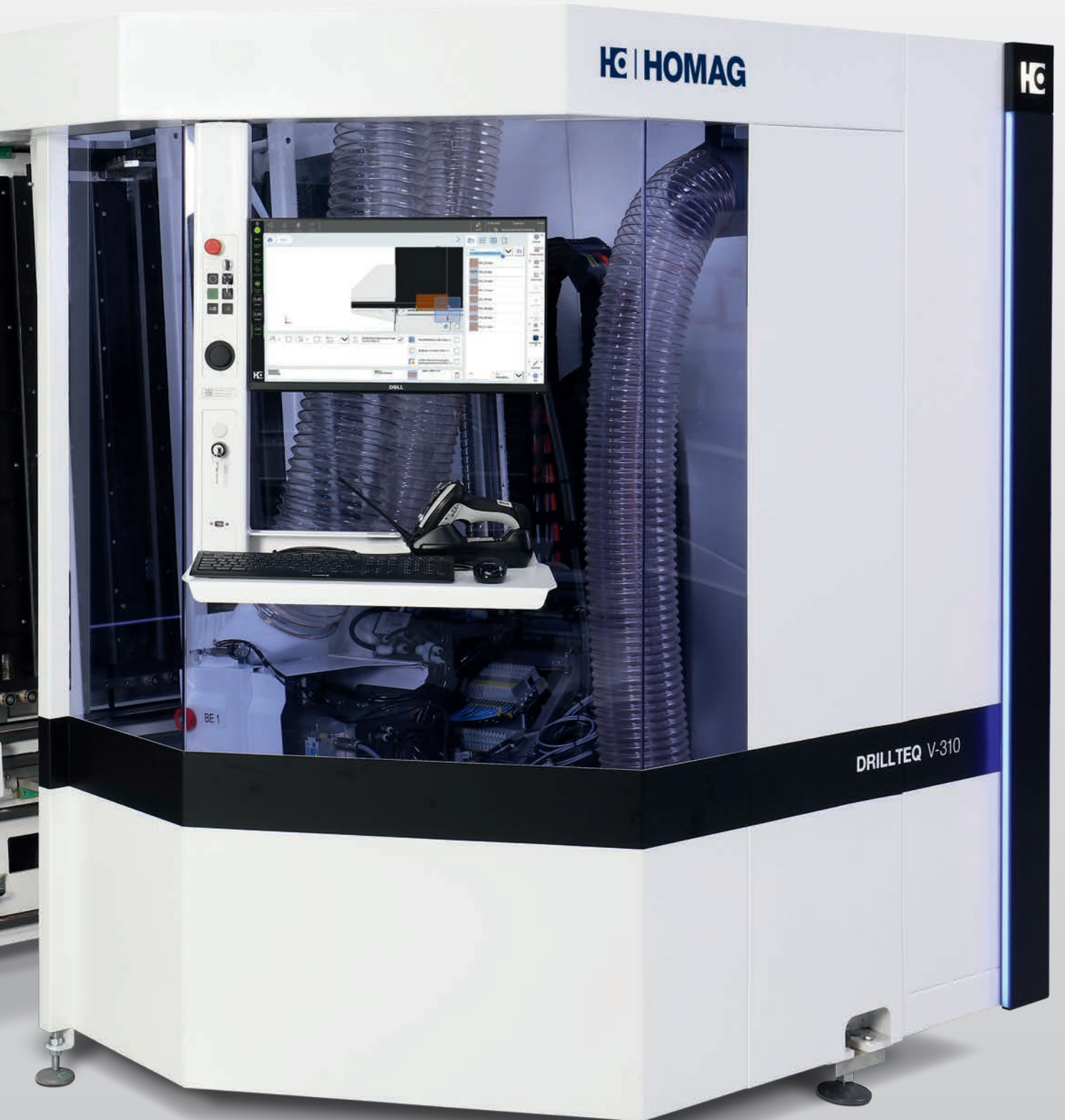

## Quality and innovation in every detail

Innovative solutions for every task. Superior technology right from the start. Every customer benefits from HOMAG's system expertise. Our processing centers represent the sum of decades of experience in machine and plant

engineering. Identical system components, standardized control technology and ergonomic operation ensure greater productivity. New technologies for processing variable workpiece shapes in high quality.

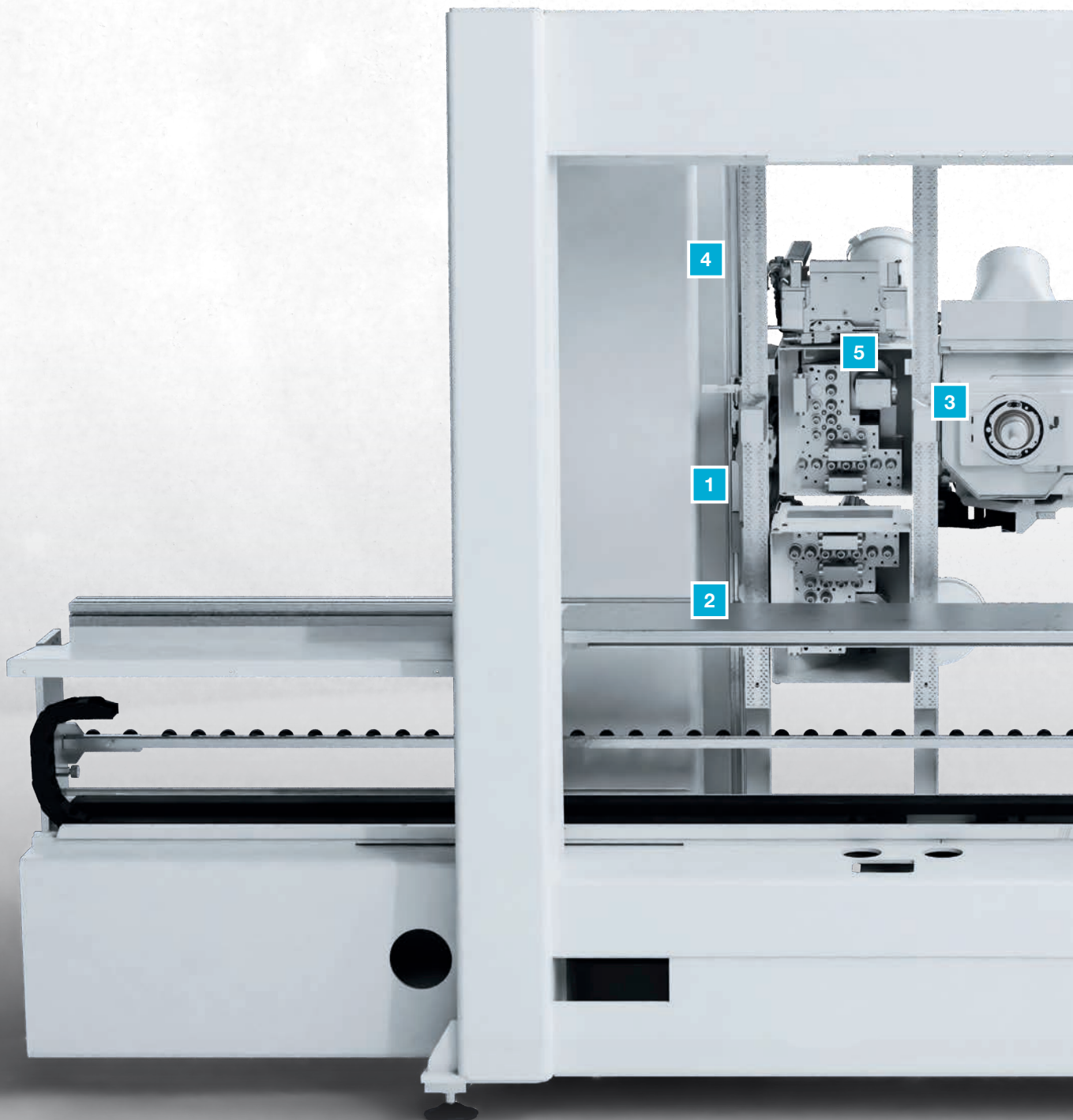

- 1** Upper boring gear in 3 equipment variants
- 2** Lower boring gear (split-head) for simultaneous machining of mirror-image workpieces (optional)
- 3** Milling spindle as 3-axis or 4-axis version with aggregate interface (optional)
- 4** Dowel unit with 2 chambers (X+ and X-) for dowel diameters of 8 mm and a length of 30, 35 or 40 mm
- 5** Glue/water nozzle for feeding the fluid into the drilled workpiece
- 6** Switch for feeding the dowel chamber (X+ and X-)
- 7** Oscillating conveyor for sorting the dowels
- 8** Glue or water pump

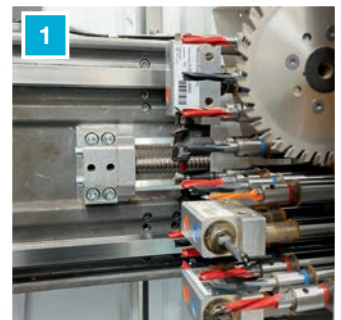
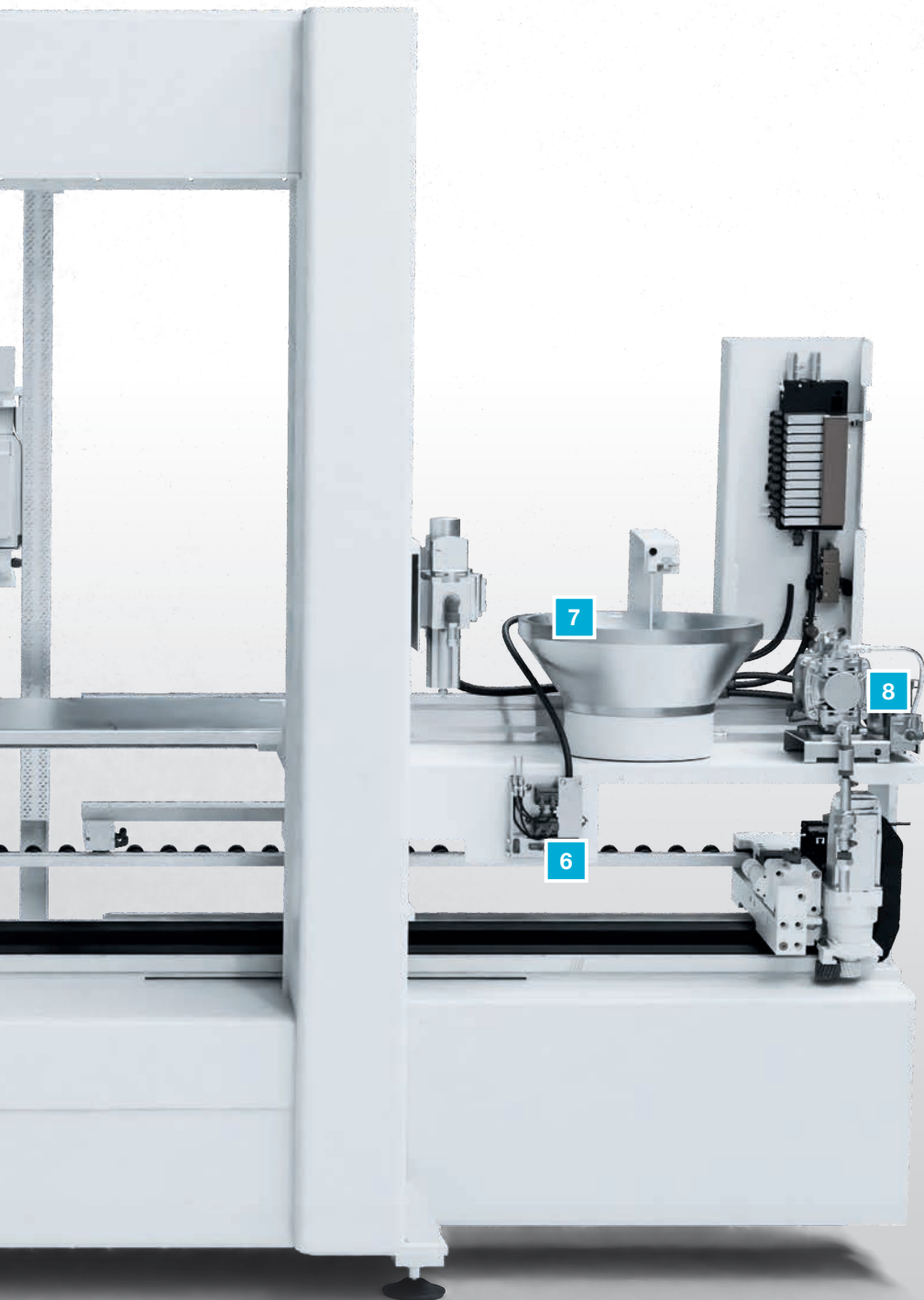

# Main spindle technology

With our main spindle technology, we set standards and increase the performance and flexibility of our machines. Our highlights are the vibration sensors to prevent damage to the milling spindles. Choose your spindle to suit your product range of today and tomorrow.

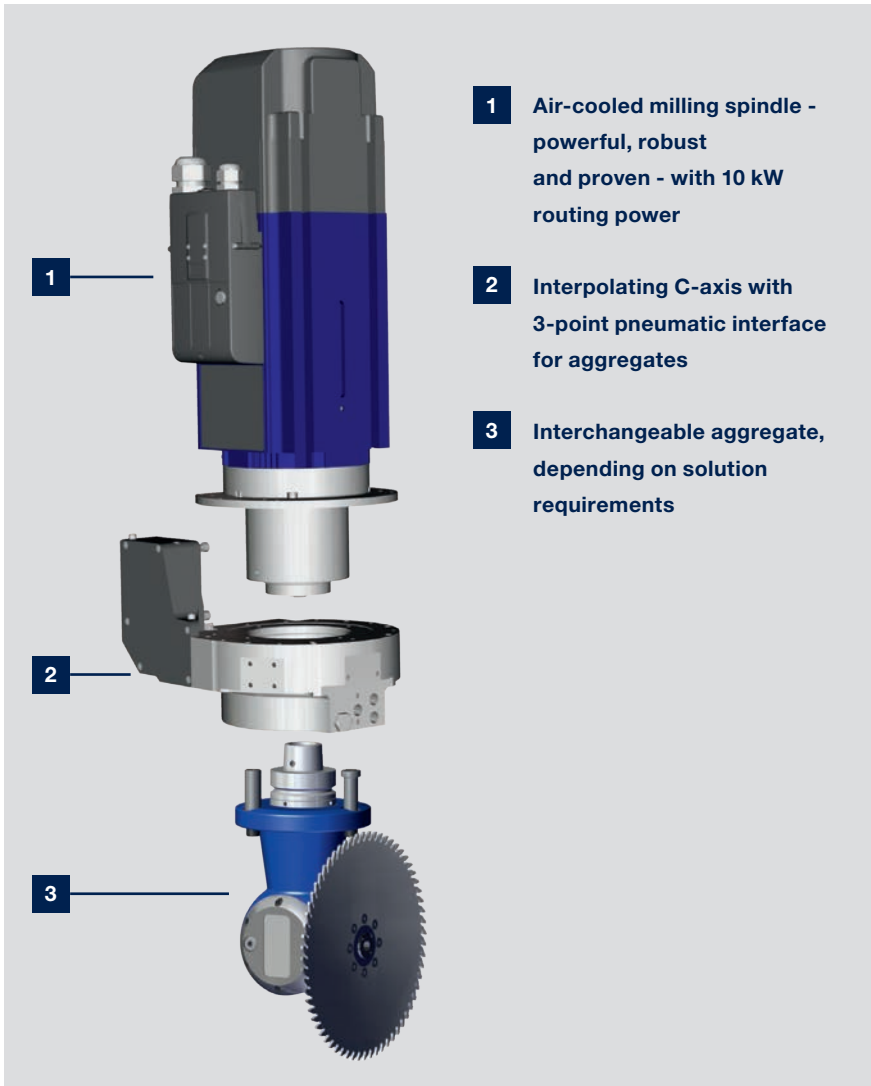

**4-axis milling spindle** with aggregate interfaces that open up virtually unlimited manufacturing possibilities. With patented technologies, the range of tasks can be expanded at any time.

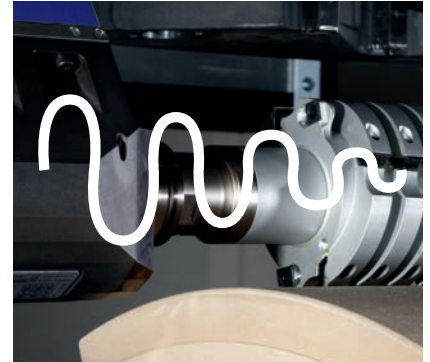

An additional vibration sensor detects tool imbalances and protects the spindle from overloads such as those caused by excessive feed rates.

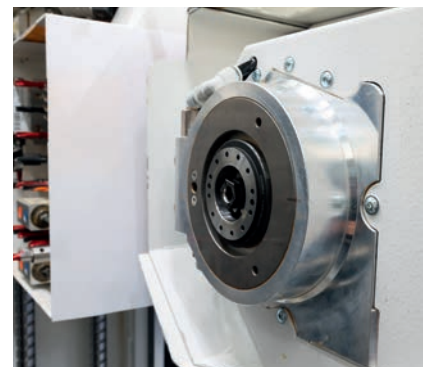

Sawing, milling and drilling with our standard aggregate interface.



**More information** can be found on our website in the brochure "Aggregate and clamping equipment"



# Aggregates and tool changers

HOMAG's aggregates provide numerous innovative technologies. They can be combined and precisely matched to your specific application situation. In this way, even special tasks are solved safely and efficiently.



**Routing unit 4-Spindles**



**Sawing/routing and drilling unit, 2-fold**



**Routing unit lock case D20/16**

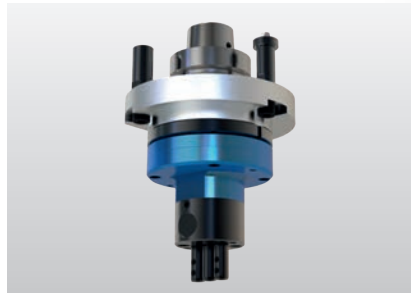

**Drilling unit Cabineo, 3 spindles**



**Corner notching unit**

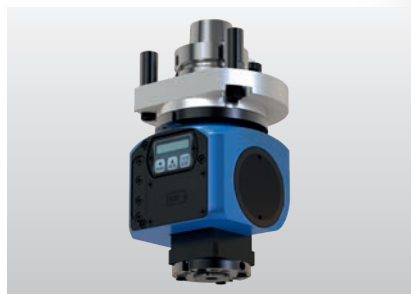

**Sawing/routing and drilling unit, Flex D, swiveling**



**Drilling unit cranked**

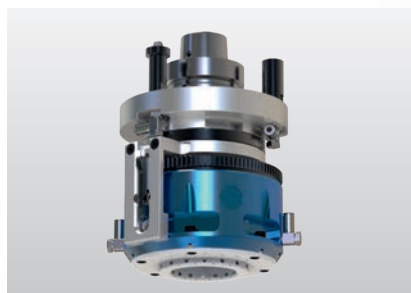

**Routing unit vertical with feeler ring, D=50**

## 8-fold tool changer

- For individual machining, 4 aggregate places and 4 tool places are provided in the changing system.
- Easy changeover by coupling the tool changer to the interior of the access door.
- With our app toolManager all tools important for you can be stored and managed. They can be easily transferred to the machining process via Drag & Drop.



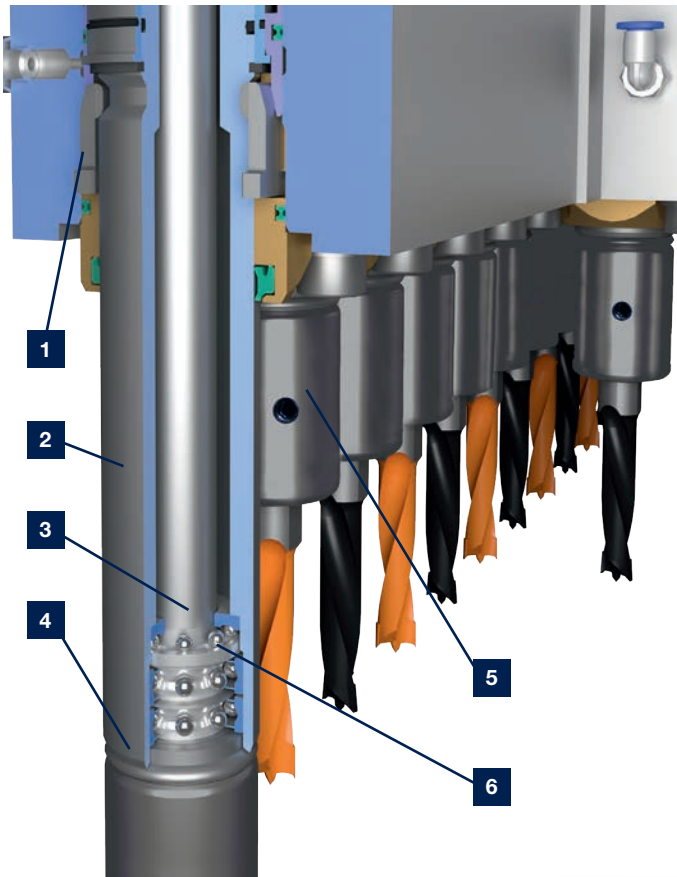

- 1** Spindle lock for exact drilling depth
- 2** Double-acting cylinder: forward and return stroke of the spindle with pneumatics
- 3** Large diameter of the sleeve and short and constant distance of the drill tip to the bearing for high lateral stability and high precision
- 4** Standing sleeve: The standing drill sleeve is issued, the drill spindle is mounted in the sleeve
- 5** Weldon change system with tensioning screw
- 6** Separate axial bearing to absorb the direct drilling forces

## HOMAG drilling technology – The best of the best

High-speed drilling technology, patented clamping of the spindle for tools. Precise drilling, fast cycles, maintenance-free and durable design.

Additional optional attachment units expand the machine's range of applications.

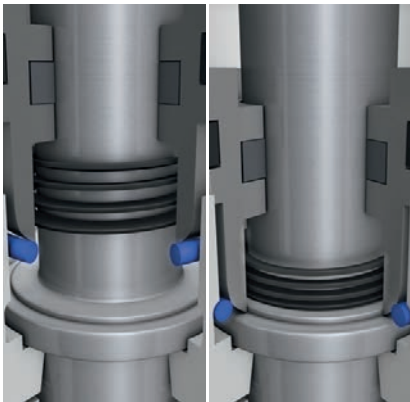

### Automatic spindle lock

Patented system for an always exact drilling depth with different materials. With speeds from 1500-7500 1/min. for high feed rates or short drilling cycles.



### Weldon change system

For a drill bit change with tools.



### NEW: replaceable spindle

Individual spindles can be replaced quickly and easily with the aid of an assembly wrench.

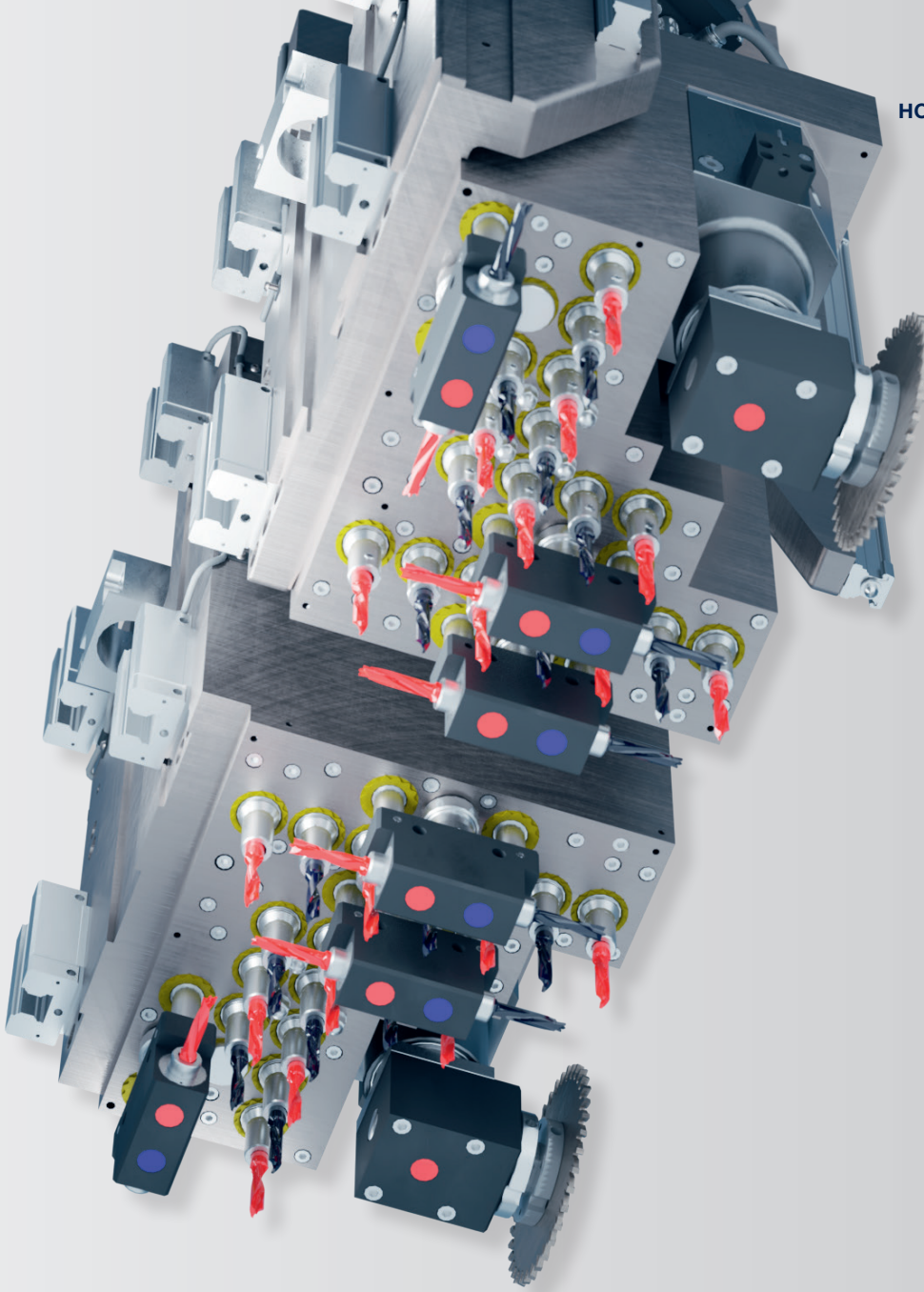

**Split-Head drilling gear**

- Synchronous machining of e.g. mirrored components by 2 individually movable Y-slides

**Upper drilling gear with:**

- 17 vertical drilling spindles [High-Speed 7500]
- 6 horizontal drilling spindles: 4 in X- and 2 in Y-direction [High-Speed 7500]
- 1 grooving saw Ø 125 mm (0° / 90°)

**Lower drilling gear with:**

- 17 vertical drilling spindles [High-Speed 7500]
- 5 horizontal drilling spindles: 4 in X- and 1 in Y-direction [High-Speed 7500]
- 1 grooving saw Ø 125 mm (0° / 90°)

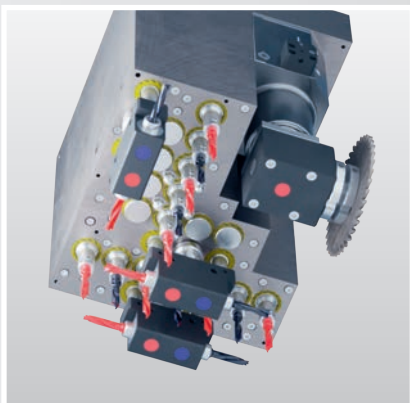

**Entry drilling gear V12H6N**

- 18 drilling spindles [High-Speed 7500]
- 12 vertical drilling spindles
- 6 horizontal drilling spindles (4X2Y)
- 1 grooving saw Ø 125 mm (0° / 90°)

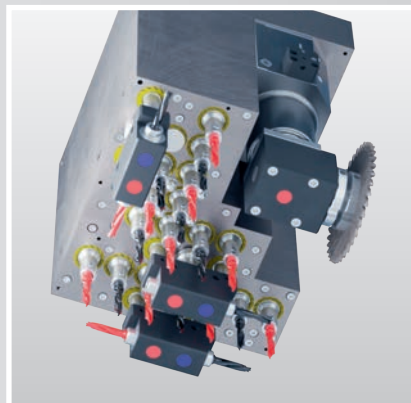

**Standard drilling gear V17H6N**

- 23 drilling spindles [High-Speed 7500]
- 17 vertical drilling spindles
- 6 horizontal drilling spindles (4X2Y)
- 1 grooving saw Ø 125 mm (0° / 90°)

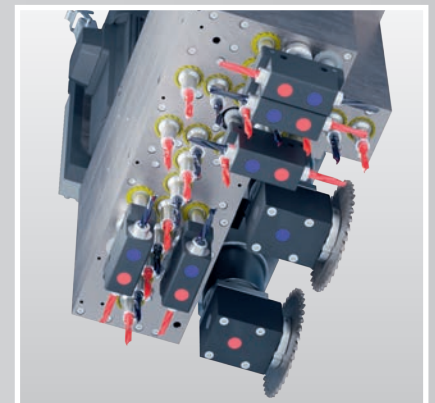

**Premium drilling gear V17H10N2**

- 27 drilling spindles [High-Speed 7500]
- 17 vertical drilling spindles
- 10 horizontal drilling spindles (6X4Y)
- 2 grooving saws Ø 125 mm (0° / 90°)



## Workpiece handling

Simple material handling through the use of gravity.



**5° degree  
incline;  
simply  
lean back**



### Protective slats at the machine infeed

For better chip guidance and an improvement of the extraction result.



**CNC-controlled collet system with 2 collets**

- Including integrated workpiece thickness measurement.
- Depending on the processing, workpiece lengths of up to 3,000 mm can be processed without re-gripping.
- Vacuumless fixing and precise positioning of the workpieces. You save 100% vacuum force here.

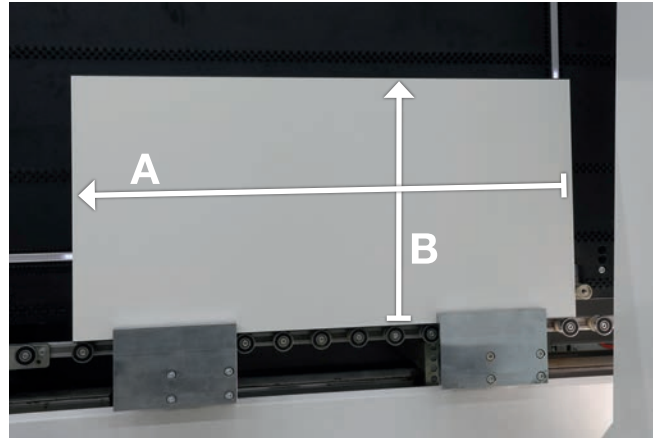

**Flexible machining - workpiece parameters**

- Length (A) from 200 mm to 3,050 mm
- width (B) from 45 mm to 1,250 mm
- Thickness (C) from 8 mm to 80 mm



**Workpiece loading and unloading area**

By means of an additional roller conveyor (~ 700 mm) in the loading and unloading area of the machine, long workpieces are optionally supported.

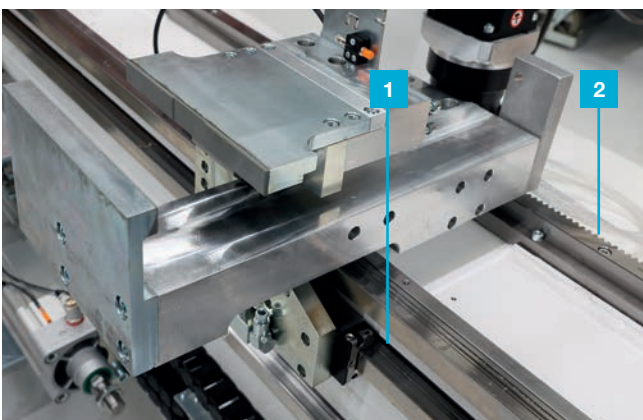

- 1 Covered linear guide with closed carriage**
- 2 Rack-and-pinion drive systems in X**

**High-quality mechanical engineering**

HOMAG stands for quality. That's why we rely on high-quality components in every series. This, coupled with the stable and solid steel construction, ensures durability and safe processes. This is how we measure ourselves.

## Tool change, operator assistance, ergonomics

Short distances and quick accessibility to all functions are the basis for an optimally designed production process. Whether workpiece handling, tool change, or the individual adjustment of the operating unit to your employees. The radius of movement is manageably small and the applications can be solved in just a few steps. The basic equipment of the machine can also be supplemented with a wide range of modules.



- The access door opens the tool changer to the operator side. This allows easy access to all stations, for setup or cleaning.
- The tool changer and the graphically supported toolManager can be operated from a central position. This facilitates any setup function.

### IntelliGuide for the tool changer

- Optical LED assistance system to support the machine operator during tool changes.
- Increased efficiency through faster operating sequences.
- Process reliability and error prevention.
- With IntelliGuide you increase your productivity while optimizing costs.





**Ergonomic machine operation**

- powerTouch monitor ergonomically adjustable in height.
- Swiveling operating unit with keyboard tray and monitor.
- Simple and individual adjustment to the relevant body size.

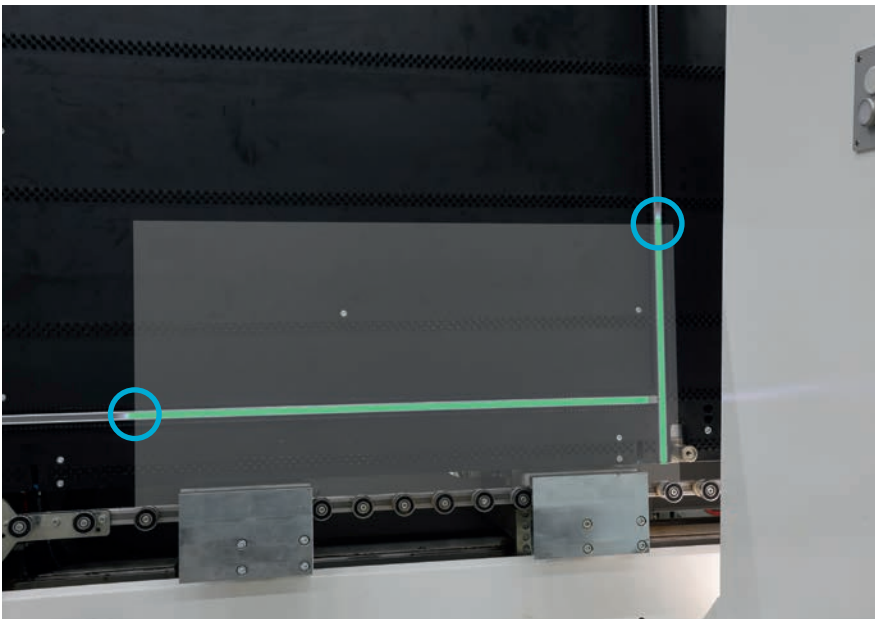

**IntelliGuide Classic**

- Optical LED assistance system to support the machine operator during loading.
- Increased efficiency due to faster operating sequences.
- Continuous accuracy check for loading without interpretation.



**Foot switch bar**

- Easy clamping of the workpieces by means of touching with the foot tip.

# Accuracy check

## TAKE ADVANTAGE OF THE ADDITIONAL SAFEGUARDING OF YOUR PROCESSES

Control of the workpiece by sensor technology in X and Y direction. Comparison with the values in the database. If the defined tolerance value is exceeded, the current process stops. At the same time, the operator receives a message to correct the workpiece. This keeps you on the safe side.

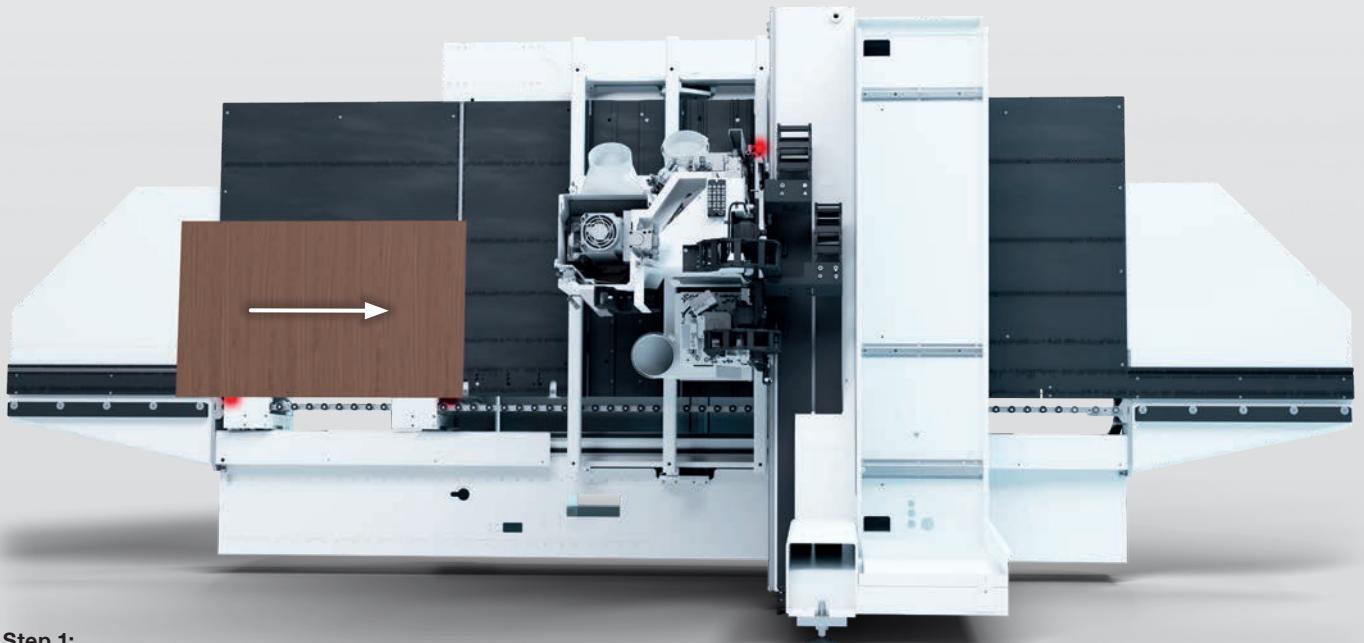

### Step 1:

- Creating the workpiece

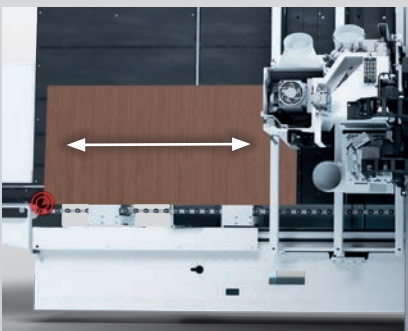

### Step 2:

- Control of the workpiece by sensor technology in X-direction. Depending on the workpiece size, the shortest path to the next sensor is selected.

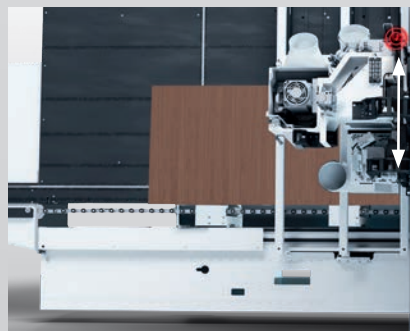

### Step 3:

- Control of the workpiece by sensor technology in Y-direction

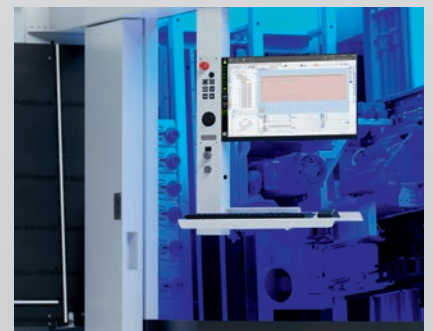

### Step 4:

- Comparison of the determined values with the program data:
- Tolerance of values < 5 mm - program is continued.
- Tolerance of values > 5 mm - program is stopped, hint to the operator to make the corrections.



# Measuring

## IF YOU WANT TO KNOW EXACTLY!

The workpiece is precisely measured by a measuring run after machining release. Optionally in X-direction or in X/Y direction. Dimension-dependent holes are then automatically corrected by any tolerances determined. You save time and gain quality.

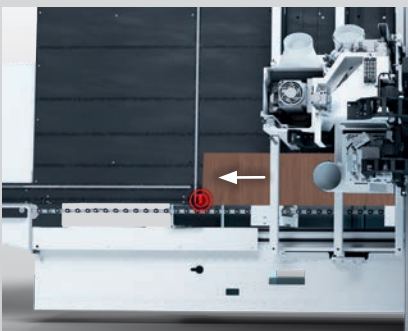
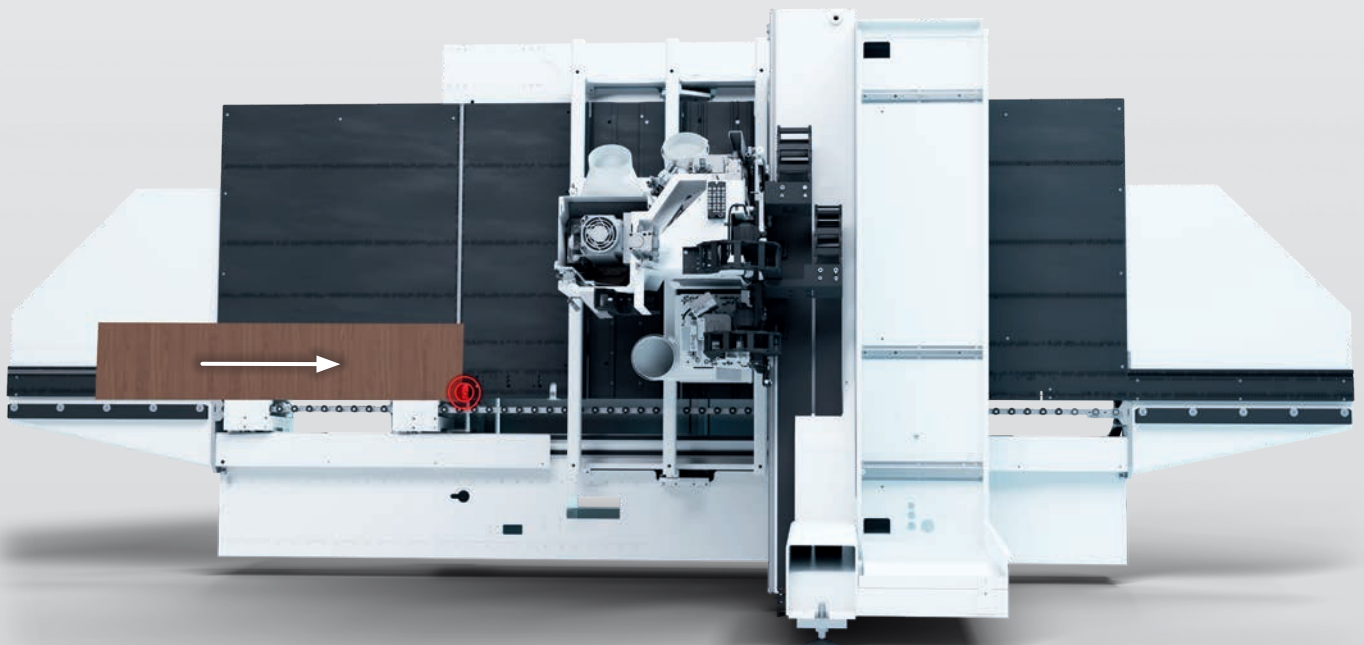

- After the workpiece has been released for machining at the stop position, a measuring run is performed in the X direction (value 1).

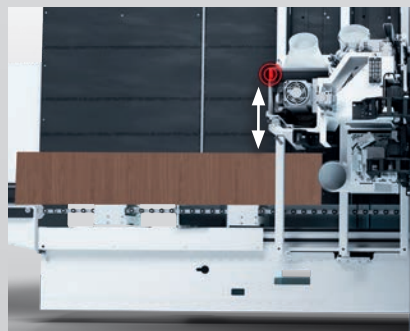

- Determination of the exact workpiece length (value 2).

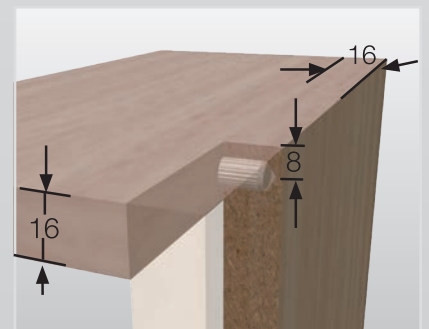

- Dimension-dependent holes are automatically corrected by any tolerances determined.

## Workpiece return

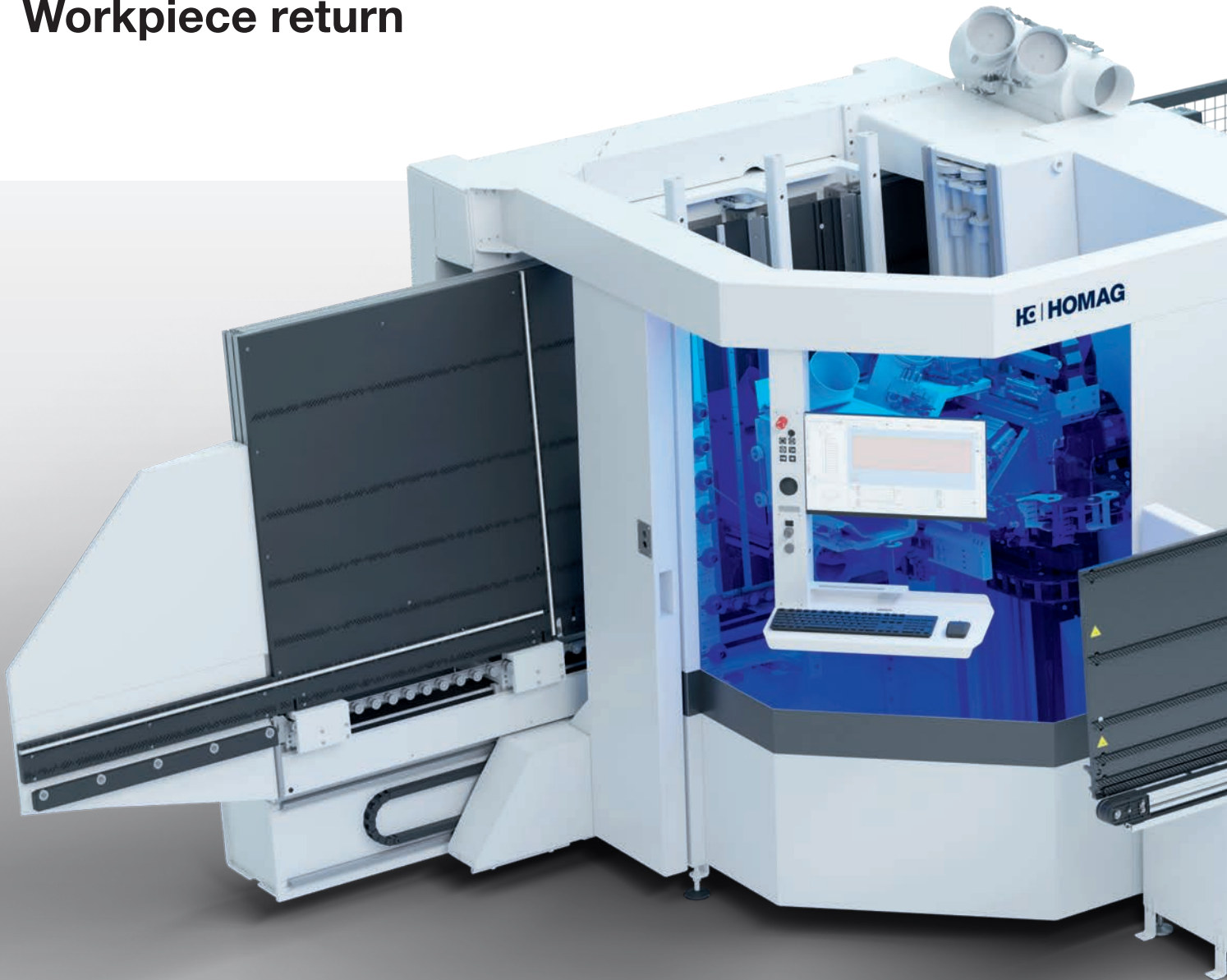

### Your advantages at a glance



**Minimize  
waiting time!**

**15%**

**Make your  
processes up to 15%  
more efficient!**



**Compact  
handling concept!**

Space requirement  
L 7.500 x W 2.850 mm

**21 m<sup>2</sup>**

**Space requirement**



**Other highlights:**

- Return for workpiece lengths up to 3,050 mm
- Plug & Play interface for later retrofitting of the return
- 3 workpieces in circulation; buffer function for a continuous sequence up to 1,900 mm
- Full integration into the user interface of the powerTouch control system



## Our dowel technology For a strong connection

The classic connection in furniture construction is a fixed connection by means of glue and dowels. With the DRILLTEQ V-310, this technology is located at the rear of the machine to save space. Depending on requirements or customer wishes, standard dowels or pre-glued dowels for processing by means of water or white glue can be inserted here.



### Automatic feeder

- For standard dowels 8 x 30 mm, 8 x 35 mm or 8 x 40 mm.



### Fill level monitoring

- Information to the machine operator as soon as the level falls below the fill level.



### Dowel unit

- Horizontal dowel insertion in X+ / X- due to powerful aggregate technology.
- Exact driving incl. variable driving depth of the dowels into the defined positions.



**Glue valve incl. glue flow monitoring**

- In X+ / X-, fluids can be fed into bores using precisely aligned and adjustable gluing technology.

**Glue nozzle cleaning**

- At preset intervals, the machine automatically cleans the glue nozzle, extending its service life.



**DÜRR Pump Technology**

- Benefit from the in-house pump technology developed by DÜRR.
- Optionally, the system can also be designed for high-pressure technology and pumping.



## Furniture connectors

Hold together what belongs together

When working with the DRILLTEQ V-310, you will have a free choice of fastener technology in the future. Whether classic milling and drilling, or the production of pockets; there are no limits to the selection. This means that you will have full flexibility in the future and can react spontaneously to all customer requirements. An absolute added value for your application in daily business.



### Flex D aggregate

- Aggregate for the production of the miter Clamex connector

# Door processing

## Open around the clock

With the DRILLTEQ V-310, literally all doors are open to you. Whether rebate machining, the milling of a lock case, Anuba bands, or light cutouts including corner notching. All this is possible within the framework of virtual workpiece guidance. Classic room doors can also be produced in this way for craftsmen's workshops.



### Lock case machining

- Using the example of a room door with a light cutout



### Holes for hinges

- Using the example of a door with rebate



# All inclusive – Software

**WITH THIS SOFTWARE PACKAGE YOU ARE "READY TO RACE".** Thanks to 30 years of experience and multiple installations worldwide, with woodWOP you get one of the most established CNC programming systems in the world.

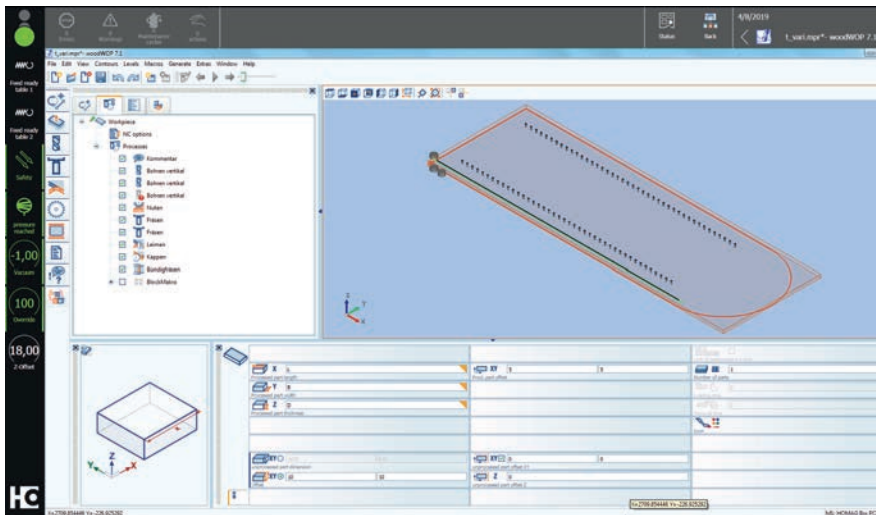

**Join us online!**

World's largest forum on the topic woodWOP:  
[forum.homag.com](http://forum.homag.com)

## woodWOP | License for Machine

- Fast and intuitive operation through simple, direct navigation
- Arbitrary use of variables for flexible variant programming
- Quick creation of own components
- More programming security through 3D graphics of workpiece and machining operations

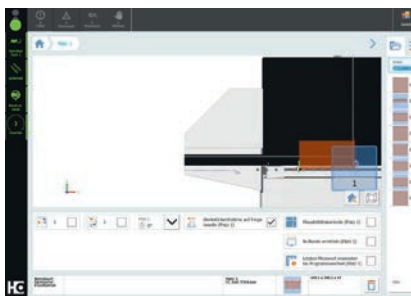

## Slot assignment

- Simple control of machine functions via soft keys
- Graphical assignment in 3D
- Rotation and mirroring of workpieces



## woodWOP DXF Basic

- Interface for CAD data import
- Basis for the generation of woodWOP programs

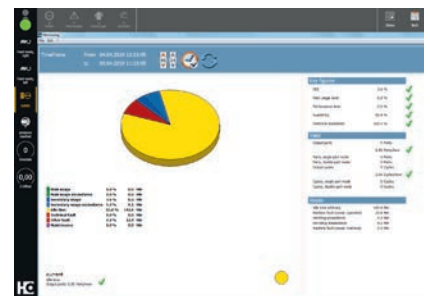

## MMR Basic

- Recording of quantities and actual operating times at the machine
- Integrated maintenance notes for optimal time- and quantity-based planning and execution of maintenance work



# Option – Software

**ADDITIONAL SOFTWARE MODULES** allow you to further optimize your processes.

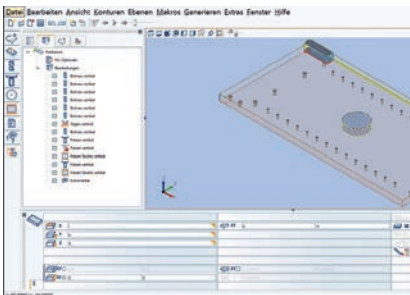

### woodWOP | License for Office

- Single-user or network licenses available
- Incl. DXF import and CAD plug-in with numerous drawing and editing functions.

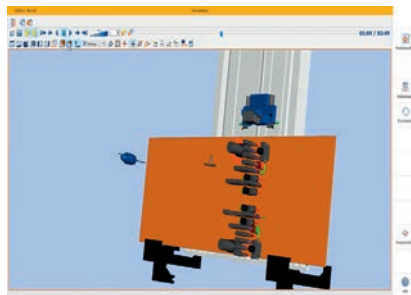

### woodMotion

- For simulation and analysis of woodWOP programs.
- Batch simulation of production lists.

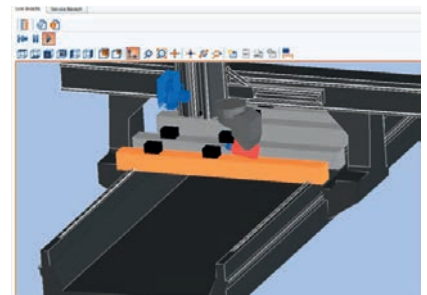

### CollisionControl

- Automatic machine stop in the event of an impending crash situation.
- Display of the crash situation as a snapshot with colored collision bodies.



### Barcode reading system

- Fast call-up and allocation of machining programs via barcode scan

## SOFTWARE EXTENSIONS

1. woodMotion

2. CollisionControl

3. woodScout



Available as a package

# The next generation of powerTouch: **powerTouch2**

Faster, more comfortable, clearer: Enjoy the benefits of our improved powerTouch user interface. We have optimized our standardized operating concept and further adapted it to our customers' requirements.

Controlling your HOMAG machines is now even faster and more intuitive. The new, modern design has a clear structure. The innovative touch operation allows you to achieve the desired result easily and comfortably.

With the new powerTouch generation, you can enter information at your machine even more quickly. Compared to the previous version, you can achieve a time saving of up to 30%. This is possible thanks to new features, such as automatic word completion, a pop-up keyboard that can be kept open and Windows-like functions, such as the selection of common actions directly via the start button.

Our successful powerTouch philosophy – **standardized, simple, ergonomic, evolutionary** – consistently further developed

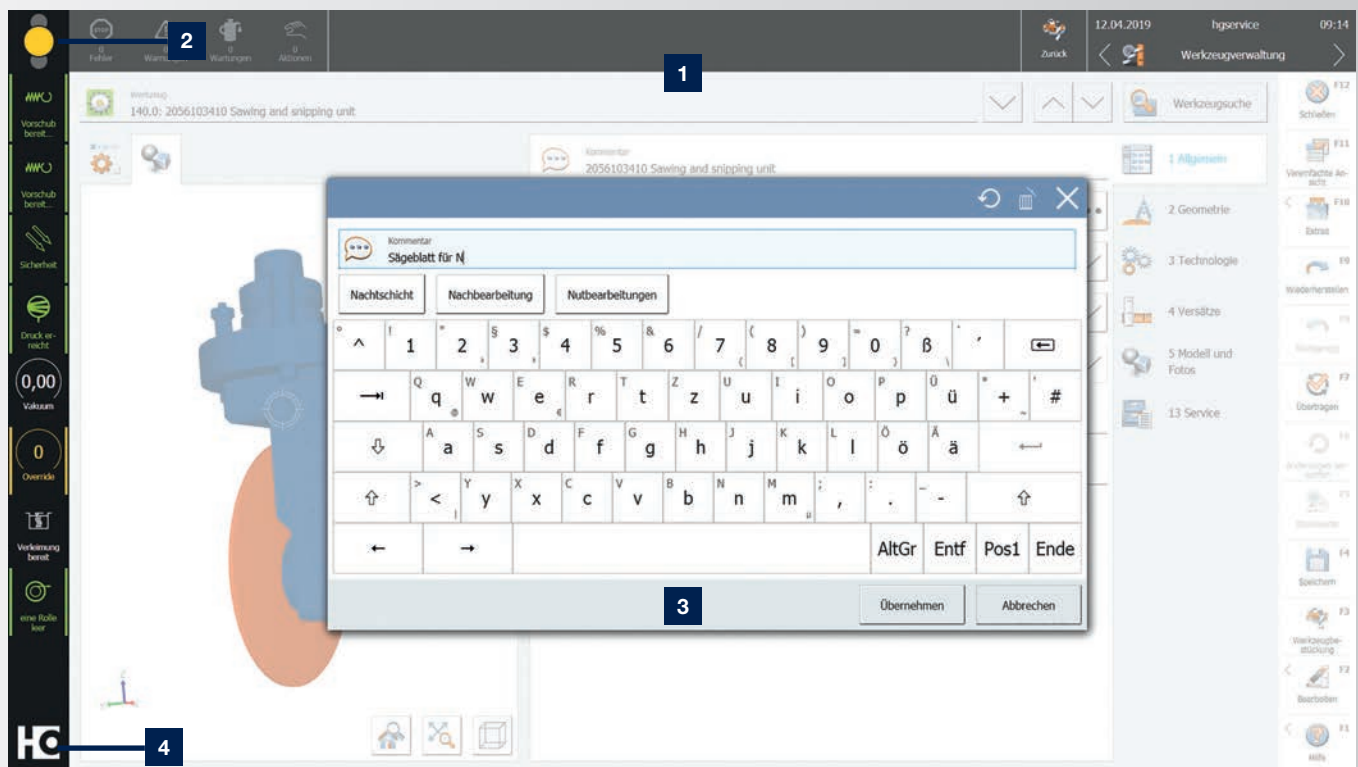

- 1 The powerTouch2 screen is clearly structured. You can see all the important information at a glance, but you still have all the details.
- 2 We have also improved the traffic light dialog further. You can now directly influence the machine's production readiness by selecting actions via the traffic light icon.
- 3 A functional pop-up keyboard that can be kept open, including automatic word completion for faster entries (when you enter the first letters, frequently used applications are proposed and you can select them directly).
- 4 Enhanced "Start" menu with additional information displayed (e.g. an indication of how many messages are currently pending or status bars that show the progress of the application) and direct access to actions (e.g. confirmation of actions without having to jump to the application).

# Our safety concept

## For optimal and safe processes

The focus of the selected safety concept is on optimum interaction between man and machine. This is made possible by HOMAG safeScan technology.

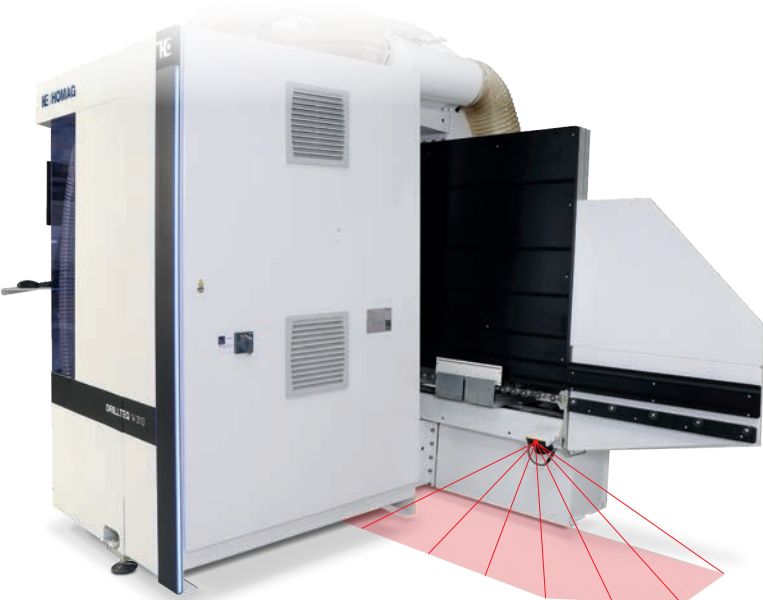
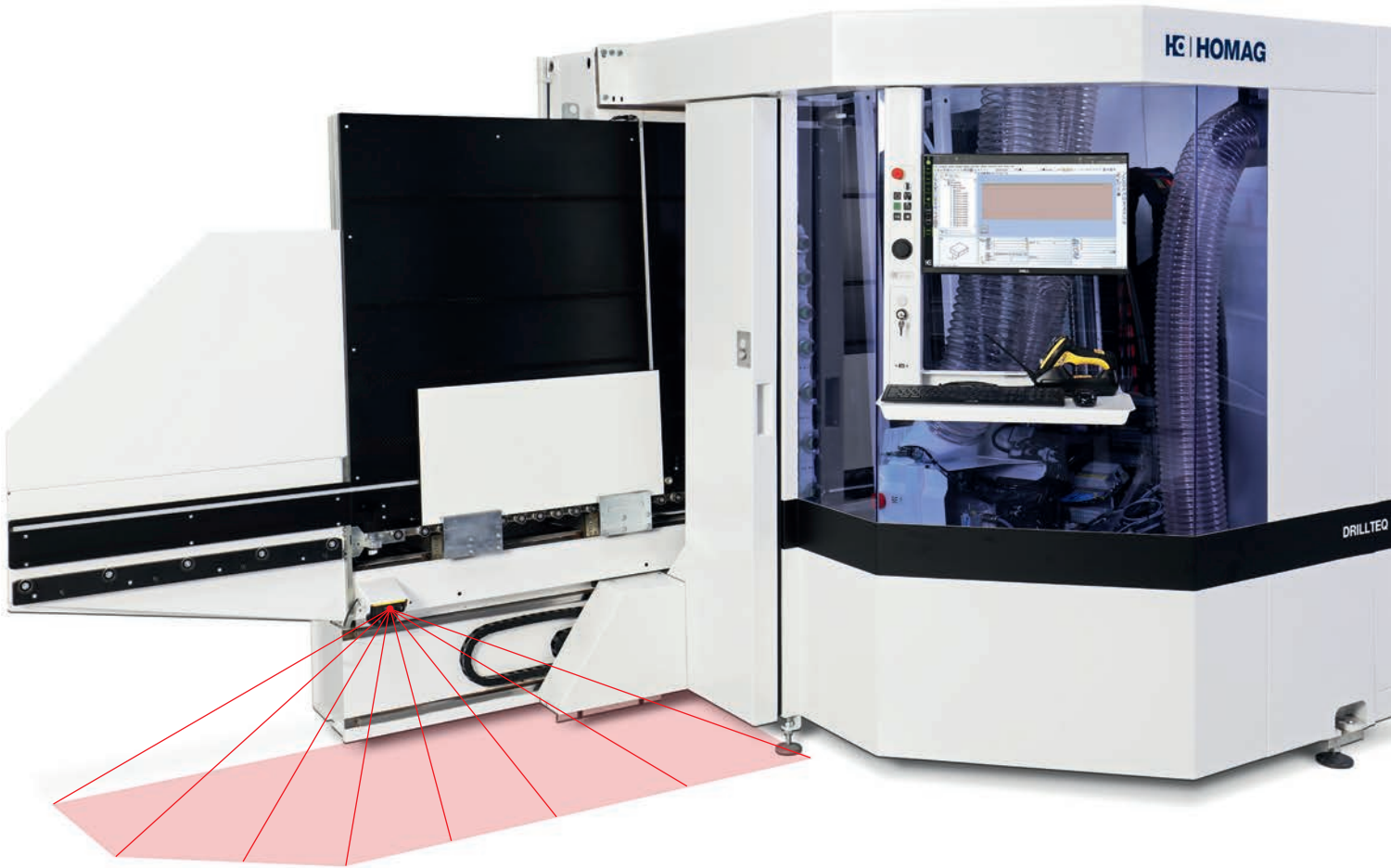

### safeScan

At the infeed and at the outfeed there is a scanner which is triggered as soon as the machine operator approaches < 900 mm to the loading or unloading area.

The highlight of the technology is the automatic continuation of production as soon as the operator leaves the area. Thanks to Autoquit, no confirmation or restart of processing is required.

## Advantages of automatic material handling with robot support

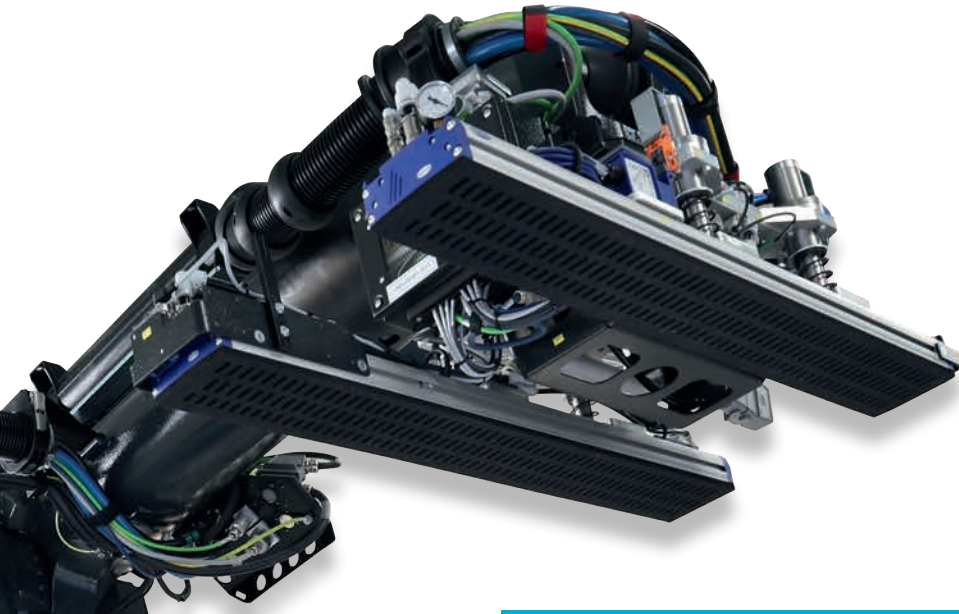

### ADVANTAGES OF ROBOT INTEGRATION AT A GLANCE:

- **High availability –**  
Machine running time can be extended to almost 100 %
- **Long lifetime –**  
no need to search for new workers
- **Highly flexible production –**  
No training of new processes necessary
- **Low maintenance operation –**  
24/7 availability (no vacation, sickness, breaks)
- **High cleanliness and low noise**
- **Ergonomics friendly –**  
Manual parts handling almost completely eliminated
- **Consistently high quality –**  
No reduction / change due to change of workers
- **Everything from a single source –**  
Liability and safety, CE, one contact, HOMAG service
- **Processing on both sides –**  
Possible due to return conveyor with reversing function

A CNC processing center with robot support forms one of the smallest possible cells of the furniture production. In this combination, the FEEDBOT increases your overall productivity. It does not have to take a break, can work around the clock on the shop floor and ensures consistently high quality. Small and medium-sized companies save a lot of

time by using the FEEDBOT D-310 and reduce the workload for their staff. The resulting flexible manpower organization allows your workforce to be used more for value-added activities and production processes. The result is added value for your plant in terms of quality, availability and performance.

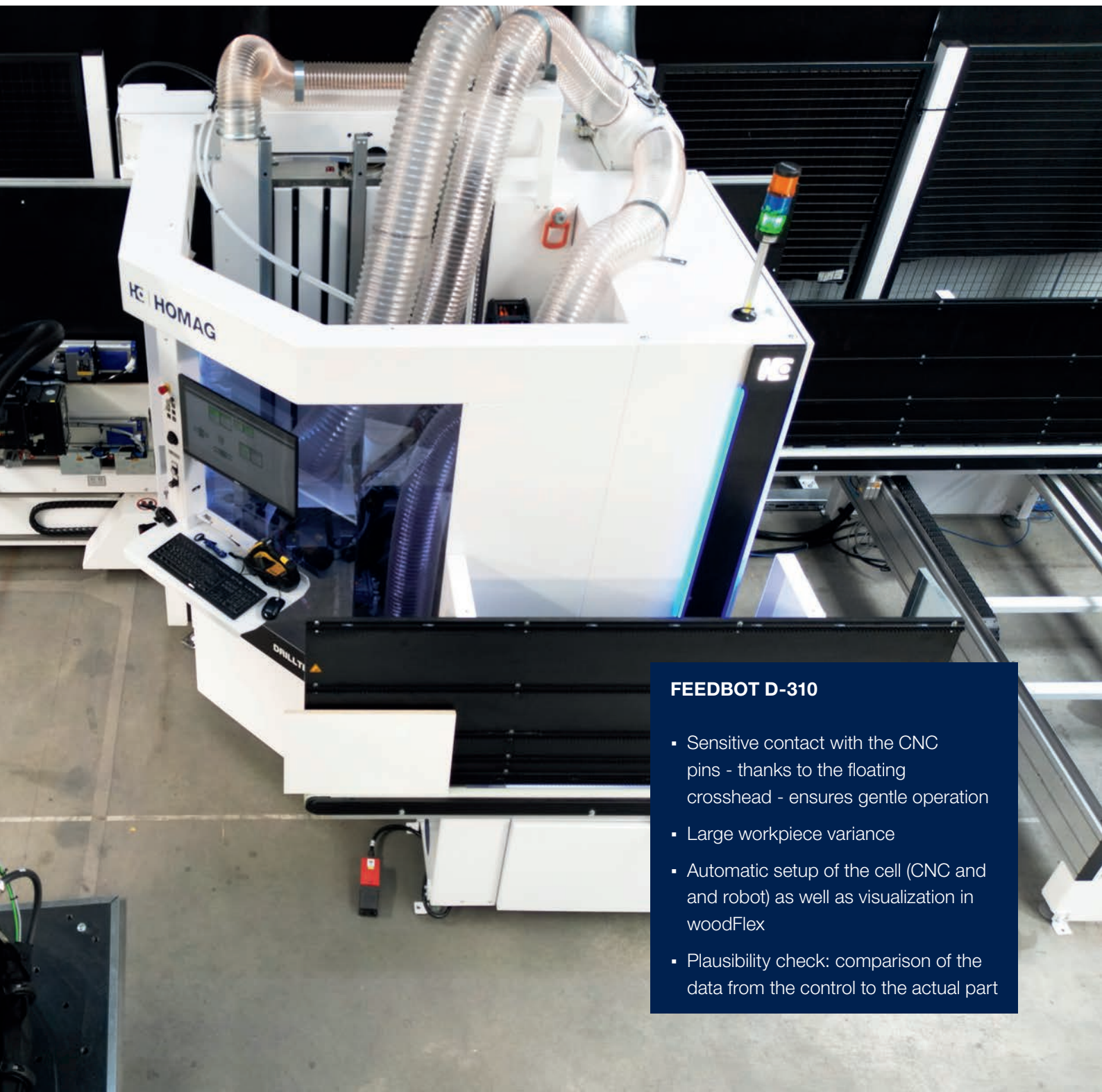

#### FEEDBOT D-310

- Sensitive contact with the CNC pins - thanks to the floating crosshead - ensures gentle operation
- Large workpiece variance
- Automatic setup of the cell (CNC and robot) as well as visualization in woodFlex
- Plausibility check: comparison of the data from the control to the actual part

# Process Overview Robot Integration

Your production becomes more flexible with the support of the FEEDBOT D-310 and the firmly defined processes more flexible and more agile. Markings on workpieces and material

increase and for your employees fatiguing, uncomfortable tasks are carried out by the robot. Even small batch sizes can be produced without any problems.

## Standard operation / normal mode

### 1 Raw parts are provided as stacks on pallets

The robot determines the position of the workpiece to be loaded by means of sensors.

The workpiece is separated from the stack by means of tilting incl. subsequent part validation.

### 2 The unmachined part will be inserted by the robot into the CNC machine

The workpiece is held by means of a compensating joint on the the robot gripper against the stop pin of the CNC machine.

Subsequently the CNC machining starts.

### 3 Removal of the finished parts

### 4 Manufactured parts are placed on the target stack

The next workpiece will be measured and inserted into the machine.

## Extension workflow through return conveyer

### Option A

Workpieces from the return conveyer **5** can be fed again to the CNC **2** (2nd run, the part was turned over for machining on both sides).

After the second run through the CNC, parts are output to the return conveyer and finally placed on the target stack **4**.

### Option B

Parts are transferred to the return conveyer **5** after the first pass through the CNC and then placed on the target stack **4**.

# Integrated control with woodFlex

This control system provides networking, has a modular design and is open for future requirements or expansions. woodFlex creates safety, optimizes processes and increases efficiency.



## woodFlex

- Visualizes the cell in real time
- Stacking patterns via drag & drop
- Fully integrated machine control system
- Connects the two machines into one cell
- HMI with familiar graphics
- Automatic setup of both machines
- Data transfer from the MPR files



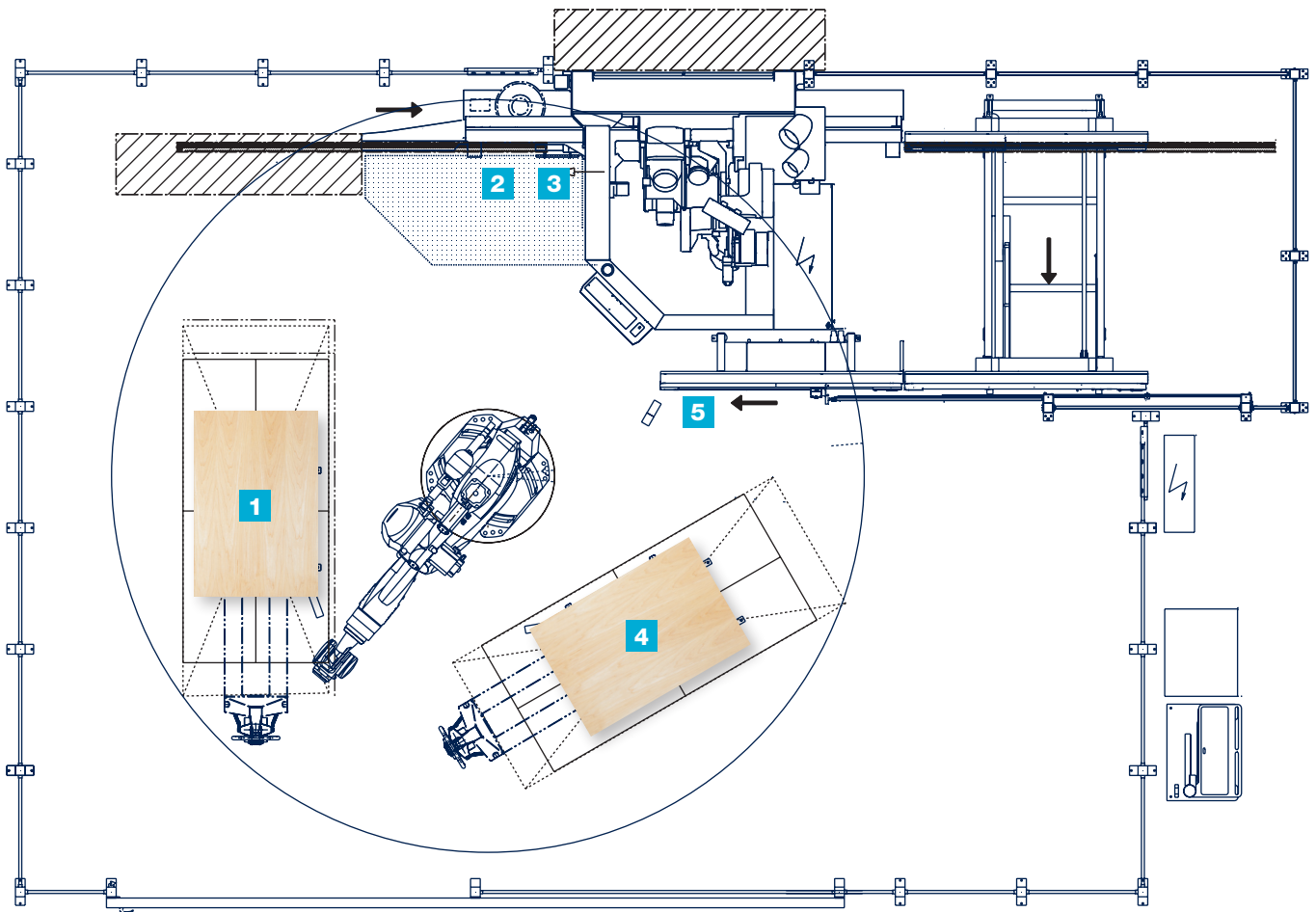

## Control and operation of the robot

**Operation** Via the HOMAG powerControl with powerTouch2.

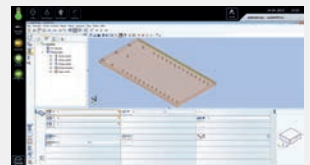

**Control** Via stacking lists or via a barcode (optional). For the application the cell control woodFlex is used. This enables automatic setup of both machines.



**2 operating modes** Automatic (robot loads and unloads CNC).

Manual (robot deactivated, operator can run CNC autonomously).

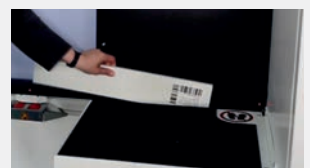

**Barcode reader** Workpieces can be identified via the label in batch size 1 operation. The barcode is applied lengthwise/crosswise centrally on the top of the blank.



# VALYOU

Our Mission, Your Performance.

## LIFE CYCLE SERVICES

Improved performance, more efficient processes, faster help, assurance of availability and smarter workin

### TEAM & COVERAGE

Largest global service network in the industry with over 1,350 personnel.

### INSTALLATION & COMMISSIONING

For a smooth start, we only let proven experts manage your setup.

### OPERATION & CONTROL

After teaching your personnel the intuitive control system, our clever apps help to make the operator's life much easier.

### MAINTENANCE & SERVICING

To keep things running, we're happy to take a preventative approach. You decide how often and how intensively you want the support to be. As we all know, prevention is better than the cure.

### eSHOP & ONLINE ADVANTAGE

A few clicks and it's fixed. Receive exclusive advantages by ordering spare parts online, depending on market availability. [shop.homag.com](http://shop.homag.com)

### HOTLINE & READINESS

When there's an emergency, we're here. Direct by phone, digitally via app or video, or with on-site support. We are close to you with over 90 regional service organizations worldwide. With more than 35,000 spare parts immediately available, we can deliver 85% of your orders fast.

### TRAINING & EDUCATION

With classroom, live online or eLearning training, we offer flexible options to help you get knowledge. We conduct over 4,000 customer training courses every year, and we even have our own training centers in 19 countries

### MODERNIZATION & IMPROVEMENT

Our modernization program is tailored to your machines and processes. We can evaluate your data and situation and advise you on the next step.

### ANALYSIS & SUSTAINABILITY

On request, we analyze all your processes with proven tools and procedures (LeanSixSigma). We have a large, certified team of experts for this purpose.

### FINANCING & CONSULTING

We offer you tailor-made financing concepts worldwide. With more than 60 years of experience and a close partner network of prominent banks and insurance companies to help us to find the right solution for you, we're always transparent and reliable in processing.





**Fast support:**  
94% resolution rate  
via our hotline

**Close to you:**  
1,350 service experts worldwide

**We get things moving:**  
Over 1,000 worldwide spare parts  
shipments each day

**No one else has that:**  
Electronic documentation on over  
150,000 machines, available in 28  
languages

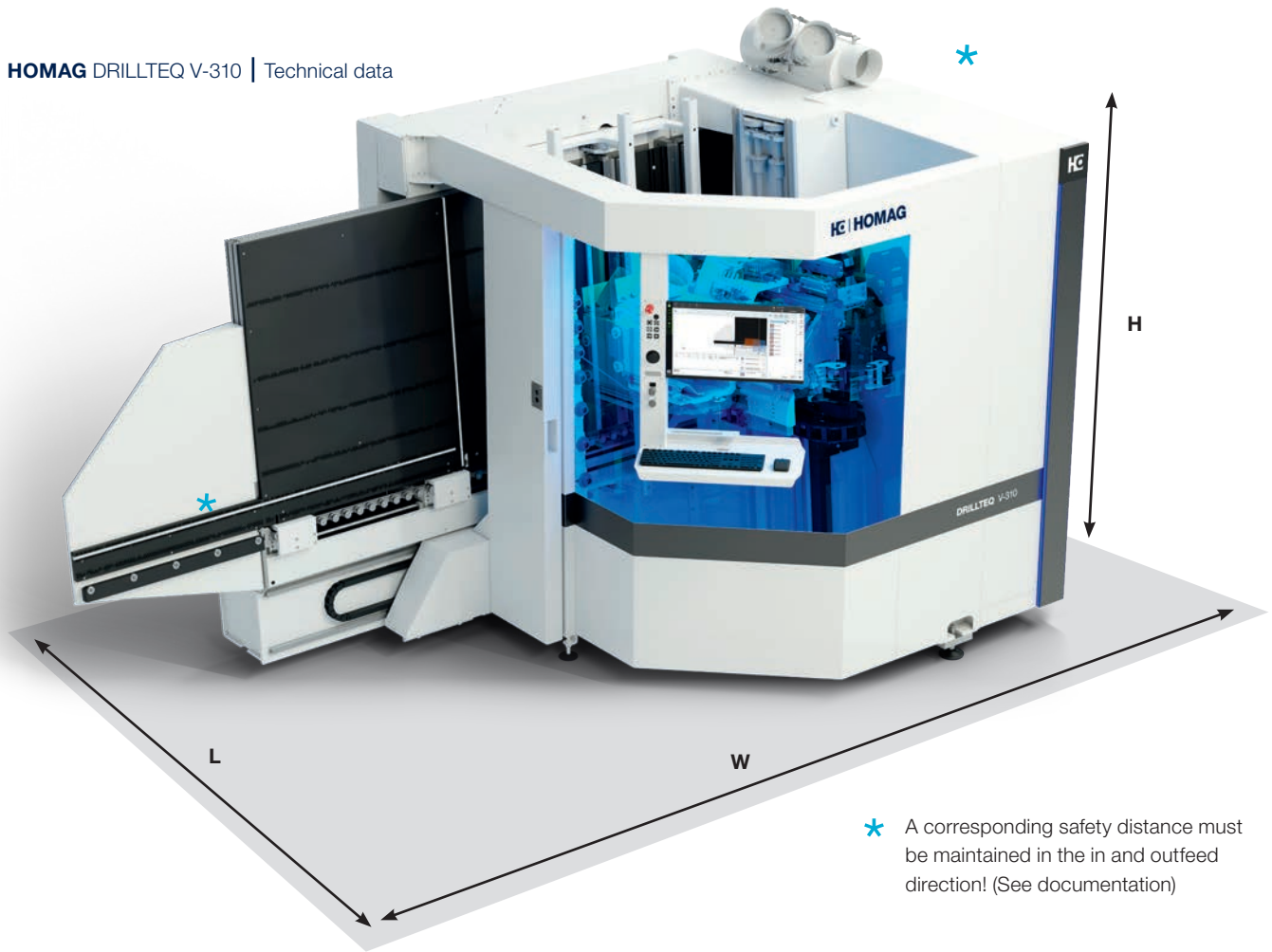

\* A corresponding safety distance must be maintained in the in and outfeed direction! (See documentation)

### Compact handling concept

DRILLTEQ V-310 with automatic workpiece return system and FEEDBOT D-310.

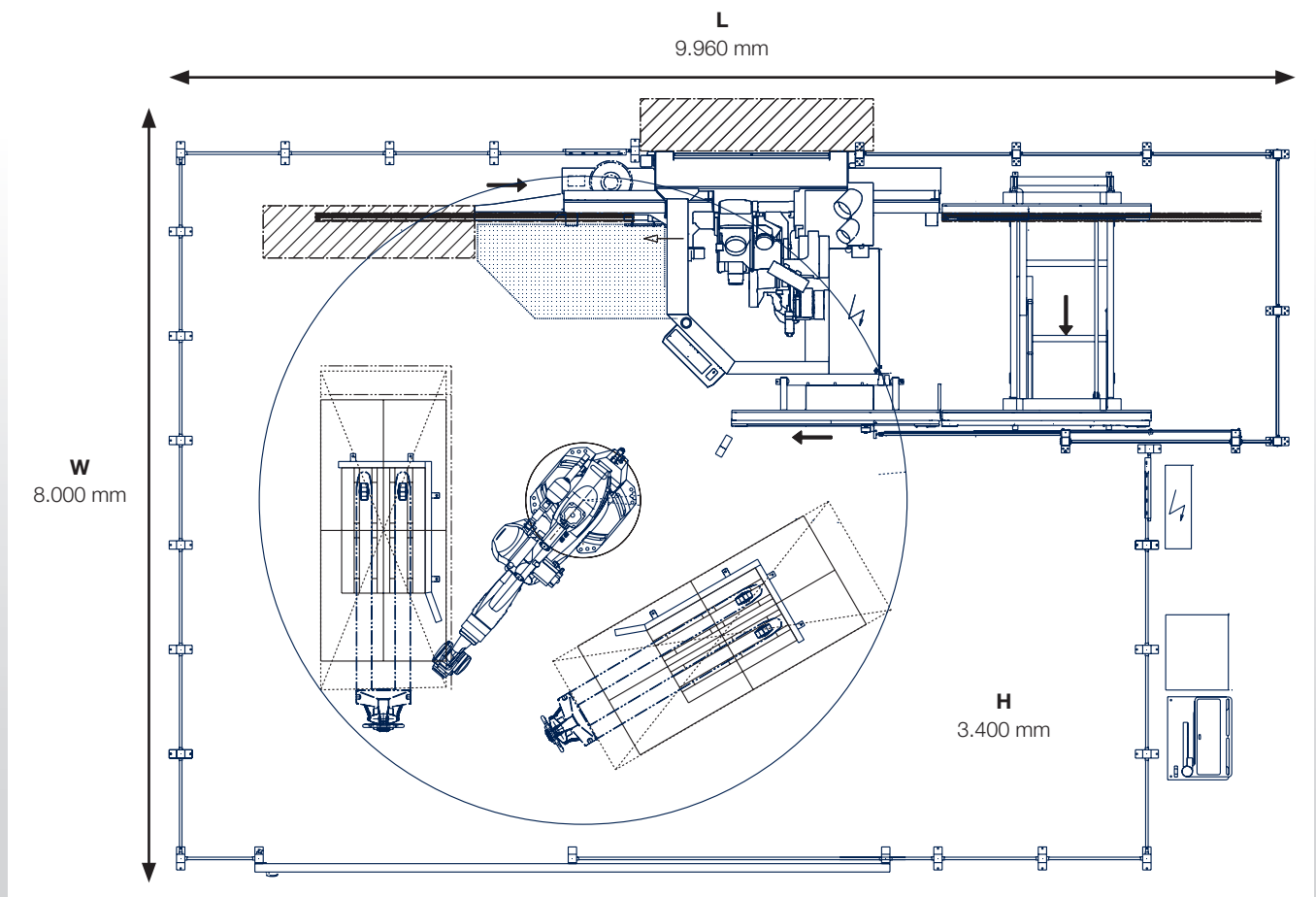

The cell can of course also be loaded manually, without a robot.

# Stacking patterns and technical parameters

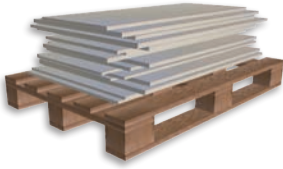

**Stacking pattern 11:**  
for batch size 1  
and series parts

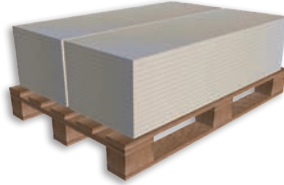

**Stacking pattern 21:**  
for series parts

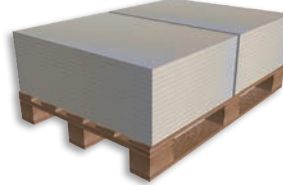

**Stacking pattern 112:**  
for series parts



**Stacking pattern 22:**  
for series parts

These stacking patterns are the standard stacking patterns for the cell.

TECHNICAL PARAMETERS	
<b>Carrier material:</b>	<ul style="list-style-type: none"> <li>- Chipboard</li> <li>- MDF</li> <li>- HDF</li> <li>- plywood, solid wood</li> </ul>
<b>Surfaces:</b>	<ul style="list-style-type: none"> <li>- Melamine</li> <li>- Raw (carrier material does not soak through)</li> <li>- Veneer</li> <li>- Laminate</li> <li>- No overlap (optional)</li> </ul>
<b>Special workpieces:</b>	Highly structured or absorbent materials and workpieces with high adhesion must be requested separately in the engineering department.
<b>Max. Stacking height:</b>	1,500 mm incl. base frame

TECHNICAL DATA					
			DRILLTEQ V-310	DRILLTEQ V-310 with return conveyor	DRILLTEQ V-310 with return conveyor and FEEDBOT D-310
<b>Workpiece dimensions max.</b>	L x W x H	mm	3.050 x 1.250 x 80	3.050 x 1.250 x 80	2.500 (3.050 option) x 1.200 x 60
<b>Workpiece dimensions min.</b>	L x W x H	mm	200 x 45 x 8	200 x 45 x 8	350 x 120 x 10
<b>Workpiece weight max.</b>		kg	60	60	60
<b>Vector speed</b>		m/min	(X - Y) 64 - (Z) 20 Ø 25	(X - Y) 64 - (Z) 20 Ø 25	(X - Y) 64 - (Z) 20 Ø 25
<b>Total machine weight</b>		kg	approx. 3.600	approx. 3.950	approx. 4.500
<b>Installation dimensions</b>	L x W x H (without extraction)	mm	5.300 x 2.260 x 2.160	7.730 x 2.835 x 2.160	11.500 x 7.000 x 2.160

Status 05/23 | Subject to technical changes, printing errors and omissions excepted. Illustrations may show optional equipment.



# HOMAG Group AG

info@homag.com  
www.homag.com

## YOUR SOLUTION